

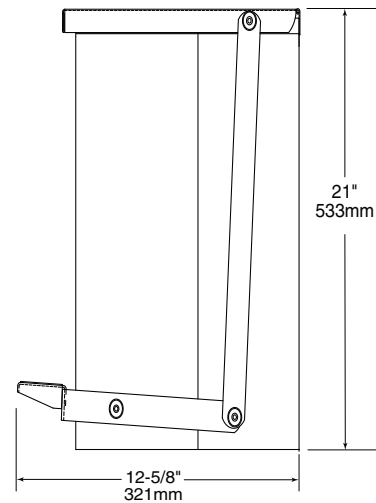

Technical Data

FOOT-OPERATED WASTE RECEPTACLE

B-220816

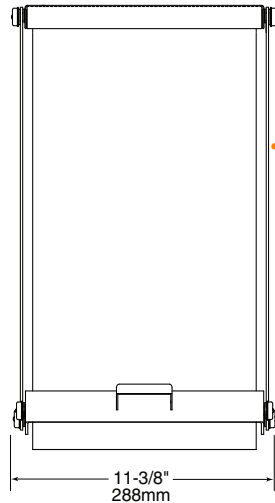

MATERIALS:

Waste Receptacle — 18-8, Type 304, 24-gauge (0.6mm) stainless steel with satin-finish, all-welded seamless construction, exposed edges hemmed for safety. Capacity 8-gal (30.3 L).

Self-Closing Lid — 18-8, Type 304, 20-gauge (0.9mm) stainless steel with satin-finish, all-welded seamless construction, exposed edges hemmed for safety. Connected to waste receptacle with a full width integrated hinge. Inside of lid has gasket for better lid closure.

Liner Clamp — 18-8, Type 304, 12-gauge (2.7mm) stainless steel with rivets to provide adjustable operation for liner servicing.

Foot Pedal Assembly — 18-8, Type 304, 16-gauge (1.6mm) stainless steel with integrated non-slip material.

OPERATION:

To insert disposable liner, place foot on pedal, pull clamps inward so that lid rests on liner clamp. Place disposable liner around the liner clamps and push clamps outward while placing foot on pedal. To empty, gather disposable liner by following these same steps, and lift bag up.

SPECIFICATION:

Foot-operated waste receptacle is flame retardant with a self-closing lid. Inside of lid comes with a gasket for better closure, non-slip foot pedal for hands-free opening. Full width integral hinge connects lid to can. Receptacle shall have clamps for holding disposable liner in place, with a capacity of 8-gal (30.3 L). Included with each unit is a free infectious and hazardous waste adhesive label to identify refuse that requires special handling. Labels meet OSHA labeling requirements. Unit is ULus listed.

Foot-Operated Waste Receptacle shall be Model B-220816 of Bobrick Washroom Equipment, Inc., Clifton Park, New York; Jackson, Tennessee; Los Angeles, California; Bobrick Washroom Equipment Company, Scarborough, Ontario; Bobrick Washroom Equipment Pty. Ltd., Australia; and Bobrick Washroom Equipment Limited, United Kingdom.